

# ***FLOMORE***

*Different By Design*

# ***Check Valves***



# Swing Check Valves

## D Series / Screwed Bonnet Screwed End - Full Opening Ductile Iron Swing Checks

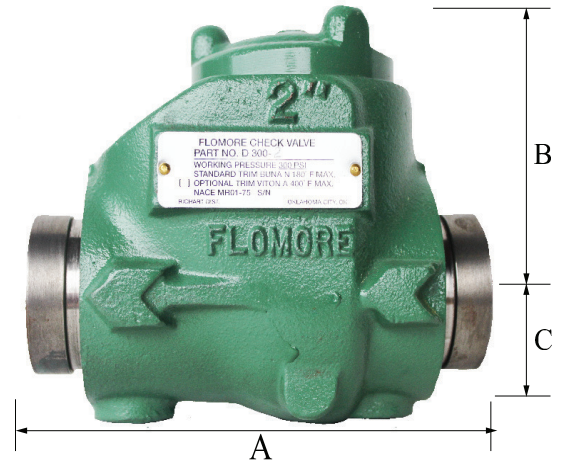
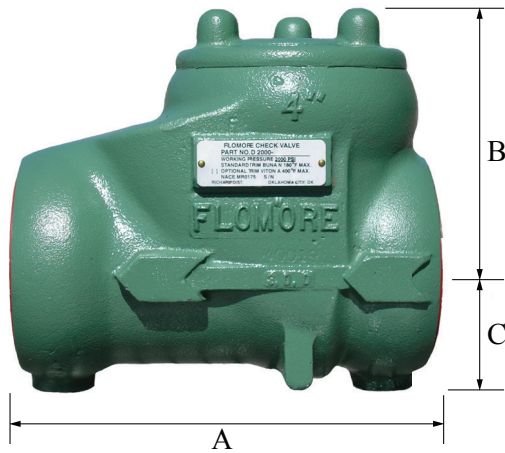

### Threaded Swing Checks

Working Pressure	Size			
	1"	2"	3"	4"
300#	D300-1	D300-2	D300-3	D300-4
600#	D600-1	D600-2	D600-3	D600-4
1000#	D1000-1	D1000-2	D1000-3	D1000-4
1500#	D1500-1	D1500-2	D1500-3	D1500-4
2000#	D2000-1	D2000-2	D2000-3	D2000-4

### Grooved End - Swing Check Valve

Working Pressure	2"
300#	D300-2GE
600#	D600-2GE
1000#	D-1000-2GE
1500#	D-1500-2GE
2000#	D-2000-2GE

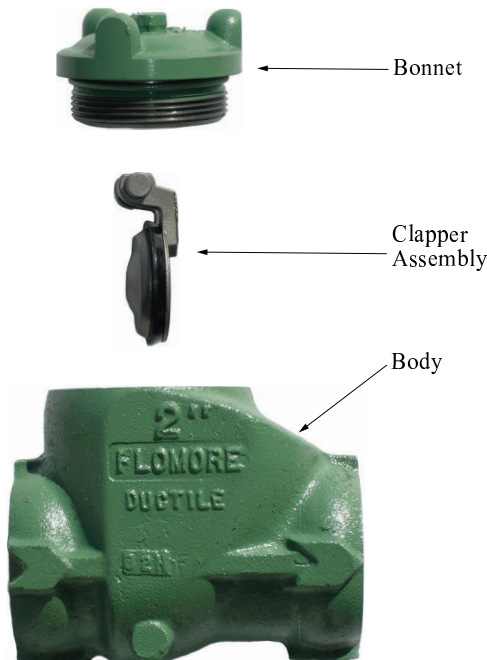

### Dimensions

Size	End	A	B	C	Flow Coefficient	Weight (lbs.)
1"	T	4.25	4.5	1.25	60	5
2"	T	6	4.25	1.75	240	11
2"	G	7	4.25	1.75	240	13
3"	T	8	4.875	2.5	665	20
4"	T	10	5.750	3.125	1300	33

T = Threaded End G= Grooved End

### Parts List

Description	Size			
	1"	2"	3"	4"
Clapper Assembly	1CA	2CA	3CA	4CA
Clapper Seal	1CS	2CS	3CS	4CS
Bonnet Seal O'Ring	1CR	2CR	3CR	4CR



# Steel Swing Check Valves

## D Series / Screwed Bonnet Screwed End - Full Opening Steel Swing Checks



## Steel Swing Checks

### Material Specifications

Part	Size	WCB Steel
Clapper	1"	WCB Steel
Clapper	2"	WCB Steel
		316 Stainless Steel (opt.)
Clapper	3" & 4"	Ductile Iron
Clapper Seal	1" - 4"	Buna-N (180°F Max)
		Viton (400°F Max) (opt.)
Bonnet Seal O'Ring	1" - 4"	Buna-N (180°F Max)
		Viton (400°F Max) (opt.)

\*NACE materials per MR-01-75 are standard on all valves

### Valve Numbers

Size	Weight (lbs.)	Flow Coefficient	Working Pressure	Model Number
1"	7	60	720#	S703-720-1
			1440#	S1503-1440-1
			1500#	S1503-1500-1
			2000#	S2003-2000-1
			3000#	S3003-3000-1
			3600#	S3603-3600-1
			5000#	S5003-5000-1
2"	16	240	2000#	S2003-2000
			2160#	S2003-2160
			3000#	S3003-3000
			3600#	S3603-3600
			5000#	S5003-5000

# *Ball Check Valves*

## *Features*

- Replaceable resilient seal with secondary metal-to-metal seal
- Nominal flow restriction
- Can be installed horizontal and vertical
- No ball spring
- Minimum parts wear from low flow rates or pulsating service

## *Steel and Stainless Steel Ball Checks*

### *Valve Numbers*

<i>Working Pressure (lbs.)</i>	<i>Material</i>	<i>Size</i>		
		<i>½"</i>	<i>1"</i>	<i>2"</i>
2000	Steel	◆	2001-1	2001CS-2
	Stainless Steel	2001S-.5	2001S-1	◆
3000	Steel	◆	3001-1	3001CS-2
	Stainless Steel	3001S-.5	3001S-1	◆
5000	Steel	◆	5001-1	5001CS-2
	Stainless Steel	5001S-.5	5001S-1	◆

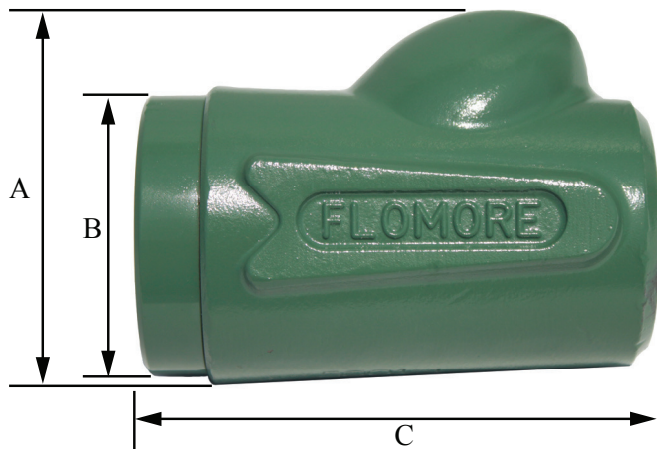

### *Dimensions*

<i>Size</i>	<i>A</i>	<i>B</i>	<i>C</i>	<i>Weight (lbs.)</i>
½"	3.06	2.375	4.208	7
1"	3.06	2.375	4.208	5
2"	4.88	3.205	6.375	16

# Ball Check Valves

## DBC Series / End Entry Ductile Iron Ball Checks

### Valve Numbers

Working Pressure (lbs.)	Size		
	1/2"	1"	2"
1000	1031-DBC-.5	1031-DBC-1	1031-DBC-2
1500	1531-DBC-.5	1531-DBC-1	1531-DBC-2
2000	2031-DBC-.5	2031-DBC-1	2031-DBC-2

### Dimensions

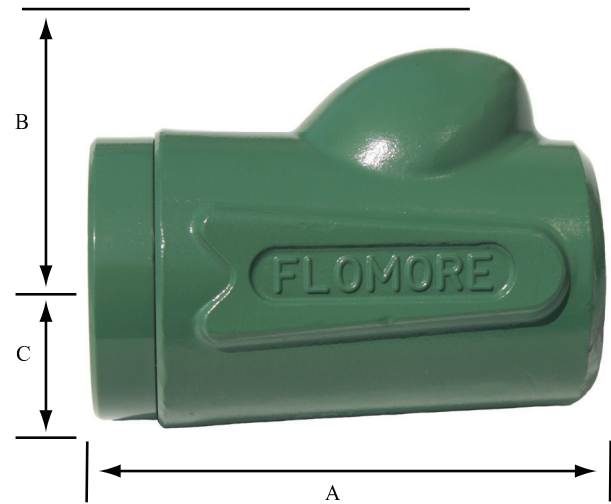

Size	A	B	C	Weight (lbs.)
1/2"	4.5	2	1.25	4
1"	4.5	2	1.25	4
2"	6	3	1.875	13

### Flow Coefficients

Size	CV
1"	30
2"	105

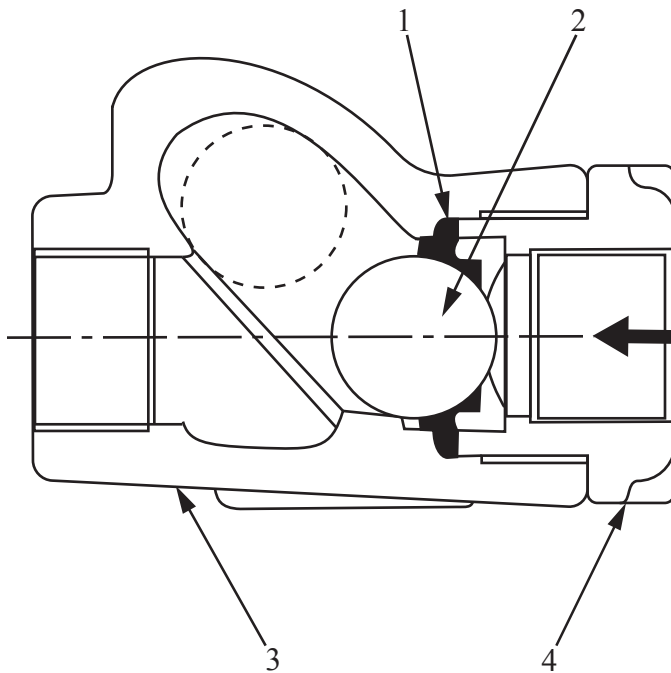

### Parts List

Item #	Description	Material	Size		
			1/2"	1"	2"
1	Seal Assembly	Buna-N (180°F Max)	20205F	20205F	30349F
		Viton (400°F Max.)	20262F	20262F	30423F
2	Ball	440 Stainless Steel	10186F	10186F	10194F
3	Body	Ductile Iron	♦	♦	♦
4	Cap	Ductile Iron	♦	♦	♦

\*We also offer cold weather seals to minus 400 Degrees Fahrenheit

# Line Check Valves

## Valve Numbers

Connection Size	Connection Type	Part #	Working Pressure (lbs.)	Material	Weight (lbs.)
1/8"	M x F	A-0672	3000	Brass	0.25
		TE-0018	6000	303 Stainless Steel	0.25
1/4"		A-0676	3000	Brass	0.25
		A-0675	6000	303 Stainless Steel	0.25
		A-1302	10,000	303 Stainless Steel	0.35
		F x F	A-0680	6000	303 Stainless Steel

## M x F Line Checks

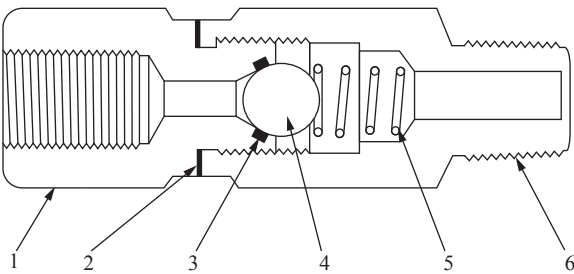

## F x F Line Check

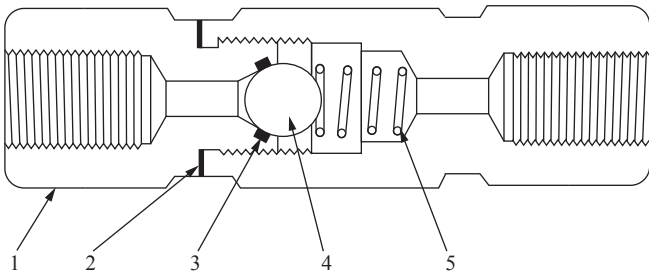

## Dimensions

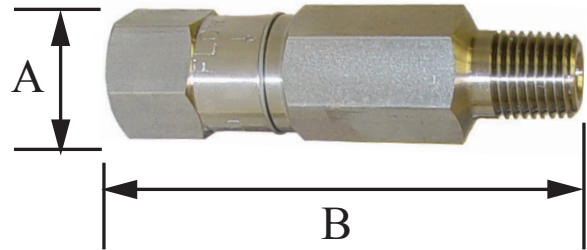

Valve Number	A	B
A-0672	3/4"	2 7/8"
TE-0018	3/4"	2 7/8"
A-0676	3/4"	2 7/8"
A-0675	3/4"	2 7/8"
A-0680	3/4"	2 7/8"

## Parts List

Item #	Part #	# Req'd.	Description	Material
1	A-0678	1	Inlet Body	Brass
	A-1297	1	Inlet Body	303 Stainless Steel
2	A-1574	1	Washer	304 Stainless Steel
3	A-0479	1	O'Ring	Buna-N
	A-2580	1	O'Ring	Viton
4	A-0054	1	3/8" Ball	316 Stainless Steel
5	A-0391	1	Spring	316 Stainless Steel
6	A-0679	1	Outlet Body	Brass
	A-1296	1	Outlet Body	303 Stainless Steel

\* Recommended Spare Parts

\*\*A-0675 Only

\*\*\*A-0676 Only

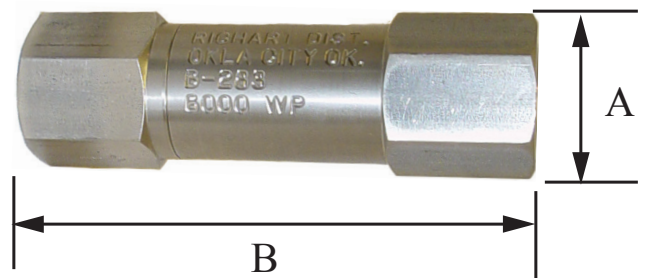

Valve Number	A	B
B-0283	1 1/8"	3 7/8"
B-1288	1 1/2"	3 7/8"

# Line Check Valves

## B-0283 & B-1288 Line Checks

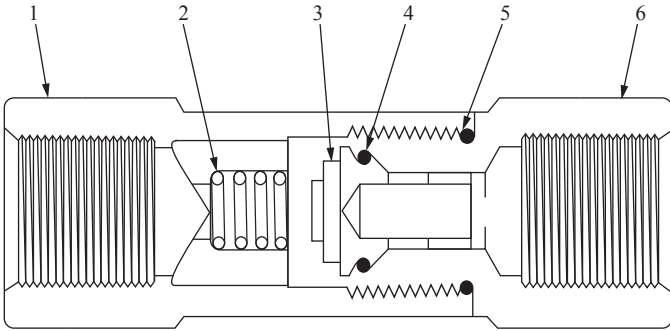

### Parts List

Item #	Part #	# Reqd.	Description	Material
1	B-0271	1	Body	303 Stainless Steel
2	A-0391	1	Spring	316 Stainless Steel
3	A-1879	1	Valve	303 Stainless Steel
4	A-0612	1	O'Ring	Buna-N
	A-2184	1	O'Ring	Viton
5	A-1959	1	O'Ring	Buna-N
	A-3979	1	O'Ring	Viton
6	A-1880	1	Bushing	303 Stainless Steel

\* Recommended Spare Parts

### Valve Numbers

Connection Size	Connection Type	Part #	Working Pressure (lbs.)	Material	Weight (lbs)
1/2"	F x F	B-0283	6000	303 Stainless Steel	3/4
		B-1288	15000	303 Stainless Steel	1 1/2

# Atomizing Nozzle

## 1/4LND-SS1 Dimensions

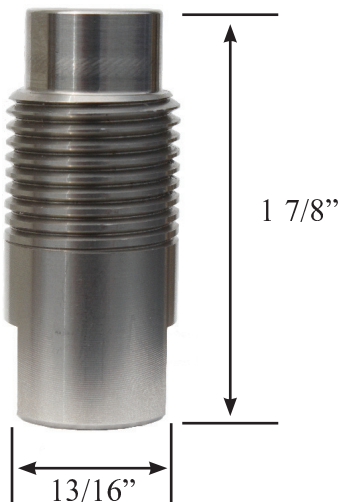

## Performance Data

Orifice Size (Nominal Inches)	Core #	Capacity (gallons per hour)										Spray Angle		
		30 psi	40 psi	60 psi	100 psi	200 psi	300 psi	500 psi	700 psi	1000 psi	40 psi	80 psi	300 psi	
0.016	206	◆	◆	◆	0.95	1.3	1.6	2.1	2.5	3.0	◆	35°	65°	
0.020	210	◆	1.0	1.2	1.6	2.2	2.7	3.5	4.2	5.0	45°	62°	72°	
0.020	216	1.3	1.5	1.8	2.4	3.4	4.1	5.3	6.3	7.5	65°	70°	72°	
0.028	216	1.7	2.0	2.5	3.2	4.5	5.5	7.1	8.4	10.0	70°	75°	77°	
0.028	220	2.6	3.0	3.7	4.7	6.7	8.2	10.6	12.5	15.0	65°	70°	73°	
0.042	220	3.5	4.0	4.9	6.3	9.0	11.0	14.2	16.7	20	72°	81°	84°	
0.042	225	5.2	6.0	7.3	9.5	13.4	16.5	21	25	30	73°	79°	81°	
0.060	225	6.9	8.0	9.8	12.6	17.9	22	28	34	40	85°	89°	91°	
0.064	420	8.6	10.0	12.2	15.8	22	27	35	42	50	82°	84°	86°	
0.076	420	10.4	12.0	14.7	19.0	27	33	43	50	60	78°	82°	85°	
0.076	421	12.1	14.0	17.1	22	31	38	50	59	70	85°	88°	90°	
0.076	422	15.6	18.0	22	29	40	49	64	75	90	81°	84°	86°	
0.076	625	19.1	22	27	35	49	60	78	92	110	70°	72°	75°	
0.086	625	23	26	32	41	58	71	92	109	130	73°	74°	77°	

Data for standard atomizing nozzle (1/4LND-SS1)



# ***FLOMORE***

## ***Richart Distributors, Inc.***

### ***Corporate Office***

3415 South I-35 Service Road  
Oklahoma City, OK 73129  
1-866-843-5654  
Fax: (405) 619-3007  
Richart@flomore.com

### ***Weatherford Branch***

2041 FM 920  
Weatherford, TX 76088  
(817) 599-9630  
Fax: (817) 599-9167  
Mike.Mayes@flomore.com

### ***Dickinson Branch***

533 East Villard Suite B  
Dickinson, ND 58601  
(701) 483-8267  
Fax: (701) 483-8268  
RichartND@flomore.com

### ***Kilgore Branch***

820 South Commerce Street  
Kilgore, TX 75662  
(903) 984-3070  
Fax: (903) 984-7901  
Tammy.Hunt@flomore.com

### ***Louisiana Branch***

#### ***Cardon Sales Company, LLC***

213 Cummings Road  
Broussard, LA 70518  
(337) 839-1704  
Fax: (337) 839-1706  
bcardon@cardonsales.com

### ***Odessa Branch***

#### ***Patterson Equipment Sales, Inc.***

1610 S. Regal Avenue  
Odessa, TX 79763  
(432) 332-3345  
Fax: (432) 332-3348  
chad@pattersonsalesinc.com

